



## Lights your World

Solutions for commercial and clean room lighting from **ELECTRA**

**Export Projects-**

Daily Need - Nigeria  
Pharma HealthCare -Eygpt  
Quality Chemicals -Uganda  
Cosmos Pharma - Kenya  
Ami Pharma - Sudan  
Batterji & Comp. - Saudi Arabia  
Magnus Pharma - Nepal  
National Health Care - Nepal  
Camus Pharma - Russia  
Air Care Ent. - Nepal  
Irfan Projects - Iraq  
Sedio Pharma - Egypt  
Zimdra Foods - Bhutan

**Food & Bevarage Industries-**

Coca Cola - Wada (Thane)  
Carlsberg -Aurangabad  
Cadbury (Sri Warna) - Kolhapur  
Colgate Palmolive - Goa  
Christy Quality Foods -Bangalore  
Pepsico Ltd. - Bangalore

**Hospitals and Operation Theaters-**

Kokilaben D. Ambani - Lokandwala (Andheri)  
KiKaBhai Premchand - Sion

# Few of our Esteemed Clients -

**ELECTRA**

## Pharma Projects-

AIRPACK FILTER & SYSTEMS  
ASTRAL PHARMACEUTICALS  
APEX ENGINEERING (FDC)  
ASTAMED HEALTH CARE

BHARAT SERUMS & VACCINATED  
BRAVO HEALTH PVT LTD  
CIPLA LTD  
CIPLA LTD  
CIPLA LTD  
CIPLA LTD  
CIPLA LTD  
CIPLA LTD  
CIPLA LTD  
CURE PHARMA  
CIRON DRUGS AND PHARMACEUTICALS  
EYTH PHARMA PVT LTD  
ENCUBE ETHICALS PVT LTD  
ELDER PHARMACEUTICAL LTD  
FILTRA TECHOPAK  
FERMENTA BIOTECH LTD  
GLAXO SMITH  
GLENMARK PHARMACEUTICALS  
GLENMARK PHARMACEUTICALS  
G K PHARMA SOLUTIONS  
G M PARITITONS  
GLOBE TROTTERS PVT LTD  
GENON BIOTECH  
GLOIBION BIOTECH SOLUTIONS  
GREEN SIGNAL BIO PHARMA PVT LTD  
HETRO DRUGS  
HEALING CROSS PHARMA  
IPCA LABORATORIES LTD  
IPCA LABORATORIES LTD  
LUPIN LIMITED  
LUPIN LIMITED  
LUPIN LIMITED

VASAI  
VADODARA  
DOMBIVALI  
PALGHAR

THANE  
KHALAPUR  
GOA  
VIKROLI  
SIKKIM  
BADDI  
PATALGANGA  
INDORE  
UGANDA  
NEW MUMBAI  
BOISAR  
AMBERNATH  
GOA  
UTTARCHAL  
DOMBIVALI  
CHANDIGARH  
THANE  
GOA  
BADDI  
THANE  
BADDI  
CHITEGAON  
GOA  
SECUNDERABAD  
KODAMBAKKAM  
HYDERABAD  
DAMAN  
DEHRADUN  
GOA  
PITHAMPUR  
PALGHAR  
BADDI

## Few of our Esteemed Clients -

**ELECTRA**

### Pharma Projects-

MACLEODS PHARMACEUTICALS LTD  
MACLEODS PHARMACEUTICALS LTD  
MACLEODS PHARMACEUTICALS LTD  
MACLEODS PHARMACEUTICALS LTD

DAMAN  
PALGHAR  
BADDI  
SARIGAM GUJRAT

MARKSONS PHARMA LTD  
NICHOLAS PIRAMAL INDIA LTD  
NICHOLAS PIRAMAL INDIA LTD  
NICHOLAS PIRAMAL INDIA LTD  
OKASA PVT LTD  
PHARMA BASE  
P I DRUGS & PHARMACEUTICALS  
SANDOZ PVT LTD  
SANDOZ PVT LTD  
SANDOZ PVT LTD  
SIROCLIN PHARMA  
SUVEN NISHTAA PHARMA PVT LTD  
UCB INDIA  
VITAL HEALTH CARE  
VENTRY BIOLOGY  
WOCKHARD LIMITED  
WOCKHARD LIMITED  
WALLACE PHARMA  
WALLACE PHARMA  
CADBURY (SRI WARNA)  
JOHNSON & JOHNSON  
PARAS PHARMA  
PFIZER PHARMA  
DR. REDDY'S  
FRESENUK KABI ONC. LTD  
VAPICARE  
ALPHA CARE  
FERMENTA

GOA  
MAHAD  
BADDI  
PRITAMPUR  
GOA  
AMBERNATH  
AMBERNATH  
MAHAD  
KALWA  
TURBHE  
THANE  
HYDERABAD  
VAPI  
NASHIK  
PUNE  
BADDI  
AURANGABAD  
BADDI  
GOA  
KOLHAPUR  
MUMBAI  
BADDI  
TURBHE  
BADDI  
KALYANI  
VAPI  
VAPI  
DAHOD

## 36W - 60W LED BOTTOM OPENING

### Description -

Family of Industrial Lighting Luminaries.  
Suitable to use in Cleanroom Areas.

**OCRBO 1901**



### Features -

Aesthetically designed housing made from CRCA  
Electro Statically Powder Coated, for excellent corrosion resistance,  
Removable led driver for easy maintainence,  
Bottom Frame, with Powder Coated Finish or SS 304 Grade,  
All screws for bottom frame are from SS 304  
Two way connectors for Loop in - Loop out.  
Suitable for Class 10,000 to 1 00 000 clean room applications  
As per IS 10322 / part1 / sec :1987

**Required Cut Out Size - 600x600mm**

### Optics -

Milky Acrylic Diffuser sealed with non hygroscopic - VHB gasket  
to ensure moisture proof and dustproof

### Installation -

Suitable for Slab Mounting, Walkable Modular Panels.

### Applications -

Biochem Industries, Pharmacuetical Industries, Chemical Industries,  
Sterilization rooms, Operation Theaters, Food & Beverage Industries,  
Hotels & Kitchen

# CLEAN ROOM FIXTURE 36-60W LED BOTTOM OPENING

## DIMENSION VIEW

**BOTTOM VIEW**

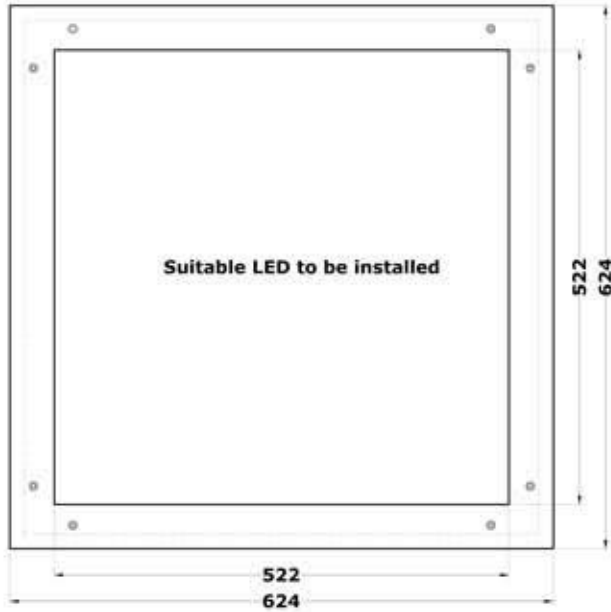

**TOP VIEW**

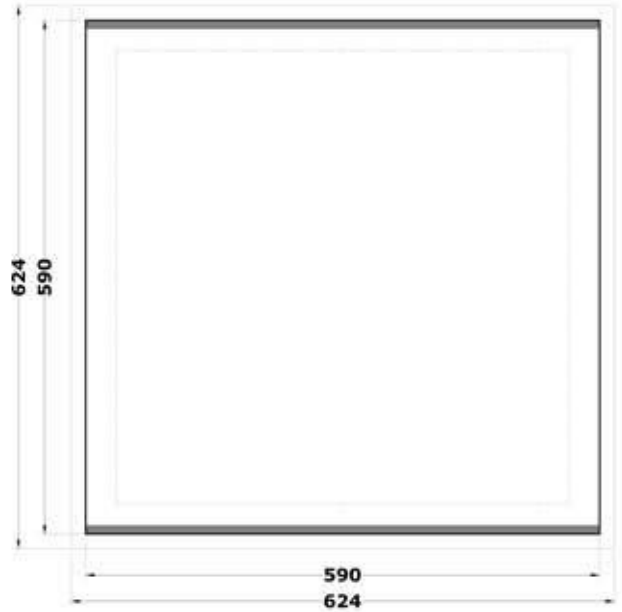

## MOUNTED & DIMENSION VIEW



## CLOSE VIEW OF INSTALLATION

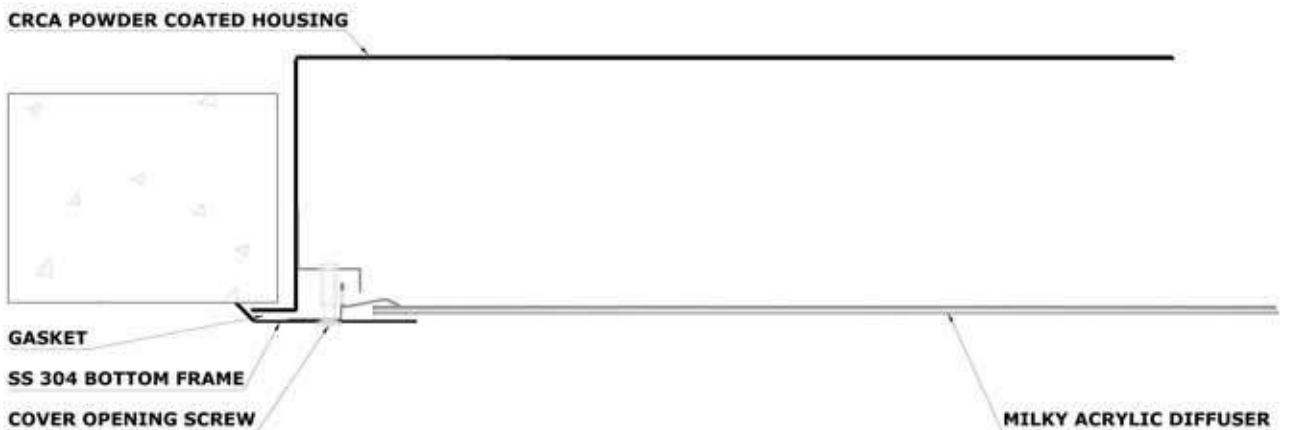

**Required Ceiling Cutout Dimension 600 x 600mm.**

					CLIENT :	
					TITLE :	
					DRG. NO.	SHT. 1 OF 1 REV
MADE	CHKD	APPD	ALTERATION	REV	<b>ELECTRA</b>	

## 18W - 25W LED BOTTOM OPENING

### Description -

Family of Industrial Lighting Luminaries,  
Suitable to use in Cleanroom Areas.

**OCRBO 1902**

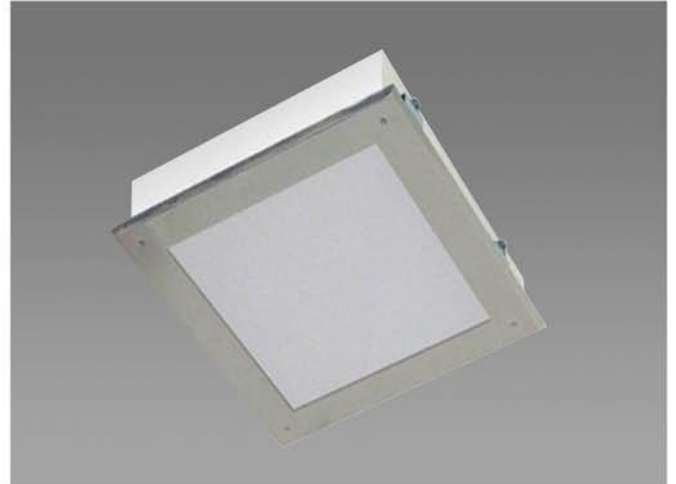

### Features -

- Aesthetically designed housing made from CRCA
- Electro Statically Powder Coated, for excellent corrosion resistance,
- Removable led driver for easy maintainence,
- Bottom Frame, with Powder Coated Finish or SS 304 Grade,
- All screws for bottom frame are from SS 304
- Two way connectors for Loop in - Loop out.
- Suitable for Class 10,000 to 1 00 000 clean room applications
- As per IS 10322 / part1 / sec :1987

**Required Cut Out Size - 300x300mm**

### Optics -

Milky Acrylic Diffuser sealed with non hygroscopic - VHB gasket  
to ensure moisture proof and dustproof

### Installation -

Suitable for Slab Mounting, Walkable Modular Panels.

### Applications -

Biochem Industries, Pharmacuetical Industries, Chemical Industries,  
Sterilization rooms, Operation Theaters, Food & Beverage Industries,  
Hotels & Kitchen

# CLEAN ROOM 18-25W LED RECESSED BOTTOM OPENING

BOTTOM VIEW

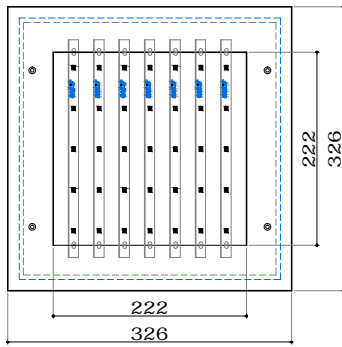

TOP VIEW

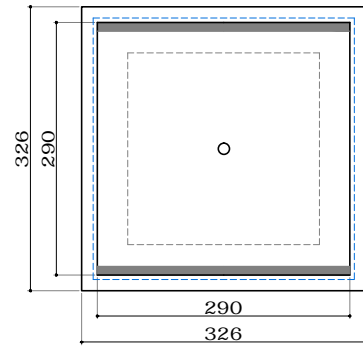

## MOUNTED & DIMENSION VIEW

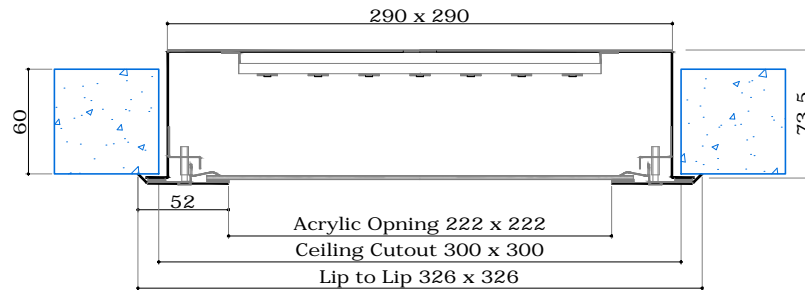

## CLOSE VIEW OF INSTALLATION

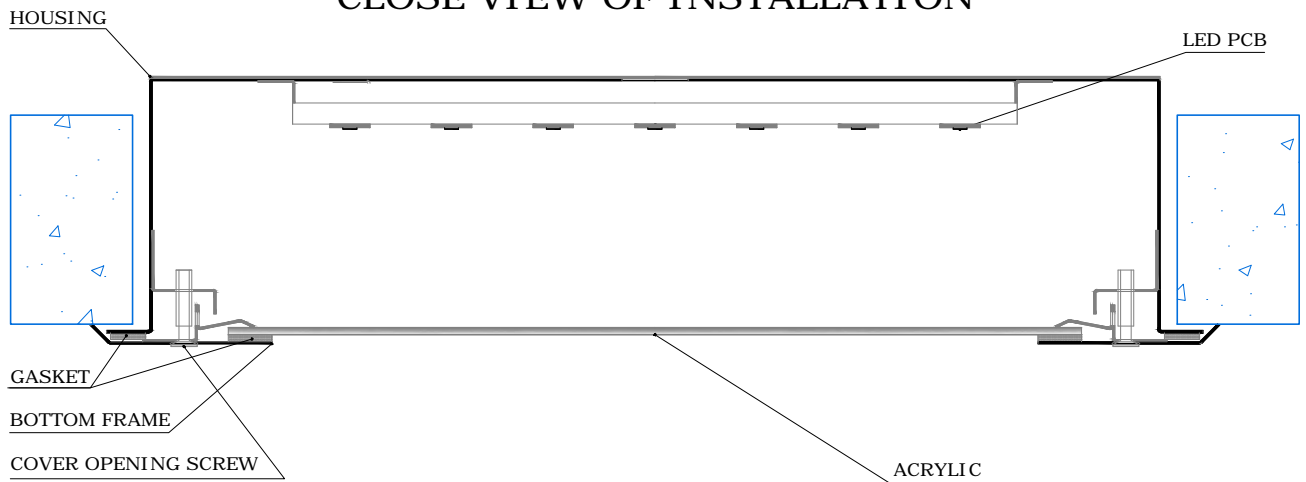

Required Ceiling Cutout Dimension 300 x 300 mm.

					CLIENT :
					TITLE : 18-25W LED Recessed Bottom Opening
					DRG. NO.                      SHT.      OF                      REV
MADE	CHKD	APPD	ALTERATION	REV	<b>ELECTRA</b>



## 24W - 45W LED BOTTOM OPENING

### Description -

Family of Industrial Lighting Luminaries.  
Suitable to use in Cleanroom Areas.

**OCRBO 1903**



### Features -

- Aesthetically designed housing made from CRCA
- Electro Statically Powder Coated, for excellent corrosion resistance,
- Removable led driver for easy maintainence,
- Bottom Frame, with Powder Coated Finish or SS 304 Grade,
- All screws for bottom frame are from SS 304
- Two way connectors for Loop in - Loop out.
- Suitable for Class 10,000 to 1 00 000 clean room applications
- As per IS 10322 / part1 / sec :1987

**Required Cut Out Size - 300x600mm**

### Optics -

Milky Acrylic Diffuser sealed with non hygroscopic - VHB gasket  
to ensure moisture proof and dustproof

### Installation -

Suitable for Slab Mounting, Walkable Modular Panels.

### Applications -

Biochem Industries, Pharmacuetical Industries, Chemical Industries,  
Sterilization rooms, Operation Theaters, Food & Beverage Industries,  
Hotels & Kitchen

**24-45W LED BOTTOM OPENING FITTING**

**DIMENSION VIEW**

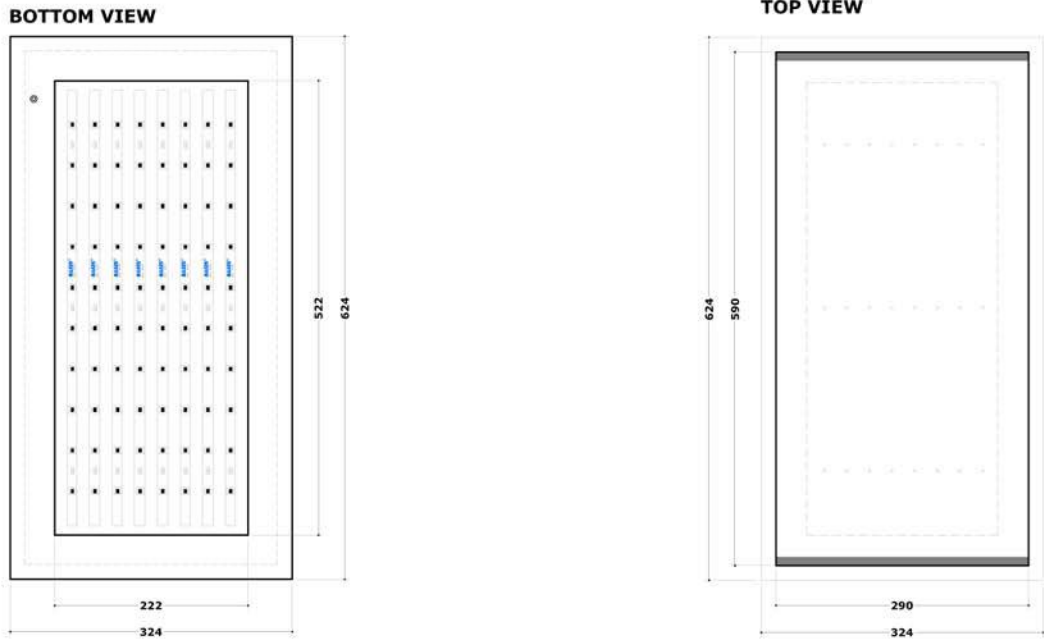

**MOUNTED & DIMENSION VIEW**

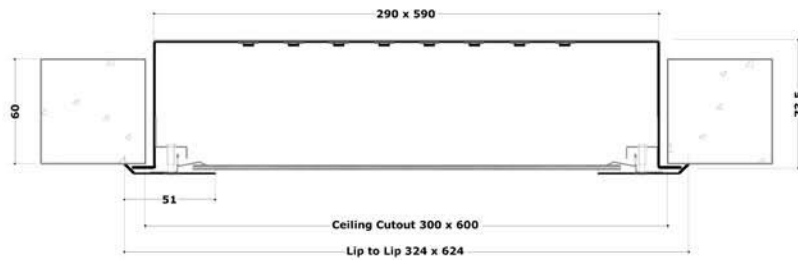

**CLOSE VIEW OF INSTALLATION**

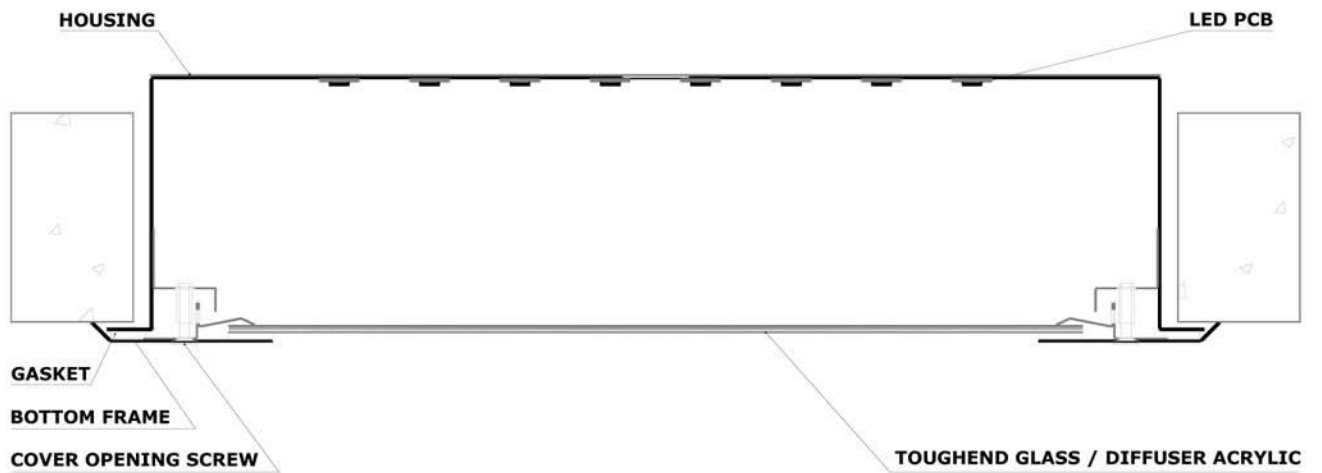

**Required Ceiling Cutout Dimension 300 x 600mm.**

					CLIENT :			
					TITLE :			
					DRG. NO.	SHT.	OF	REV
MADE	CHKD	APPD	ALTERATION	REV	<b>ELECTRA</b>			

## 40W - 80W LED BOTTOM OPENING

### Description -

Family of Industrial Lighting Luminaries.  
Suitable to use in Cleanroom Areas.

### OCRBO 1904



### Features -

- Aesthetically designed housing made from CRCA
- Electro Statically Powder Coated, for excellent corrosion resistance,
- Removable led driver for easy maintainence,
- Bottom Frame, with Powder Coated Finish or SS 304 Grade,
- All screws for bottom frame are from SS 304
- Two way connectors for Loop in - Loop out.
- Suitable for Class 10,000 to 1 00 000 clean room applications
- As per IS 10322 / part1 / sec :1987

**Required Cut Out Size - 400x1200mm**

### Optics -

Milky Acrylic Diffuser sealed with non hygroscopic - VHB gasket  
to ensure moisture proof and dustproof

### Installation -

Suitable for Slab Mounting, Walkable Modular Panels.

### Applications -

Biochem Industries, Pharmacuetical Industries, Chemical Industries,  
Sterilization rooms, Operation Theaters, Food & Beverage Industries,  
Hotels & Kitchen

**CLEAN ROOM FIXTURE  
( 40W-80W LED BOTTOM OPENING )  
DIMENSION VIEW**

**BOTTOM VIEW**

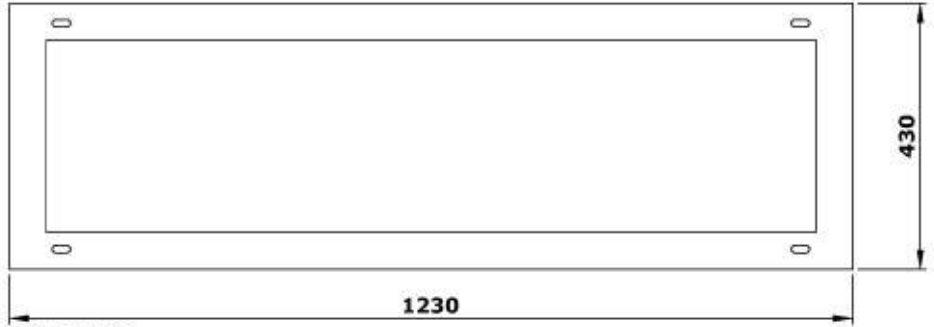

**TOP VIEW**

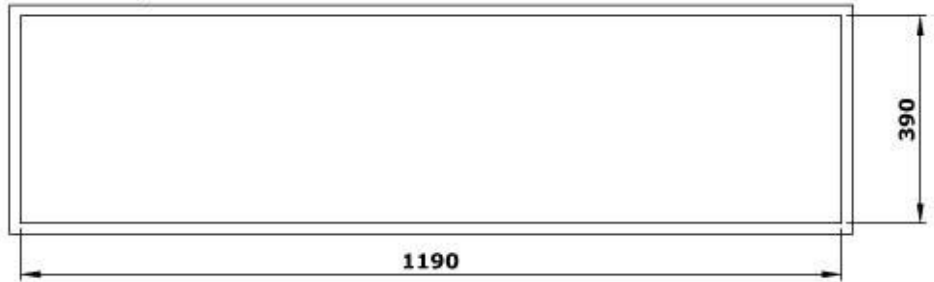

**MOUNTED & DIMENSION VIEW**

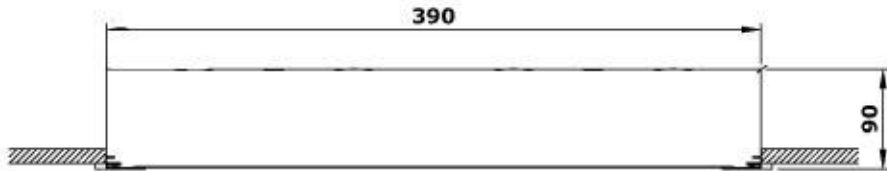

**CLOSE VIEW OF INSTALLATION**

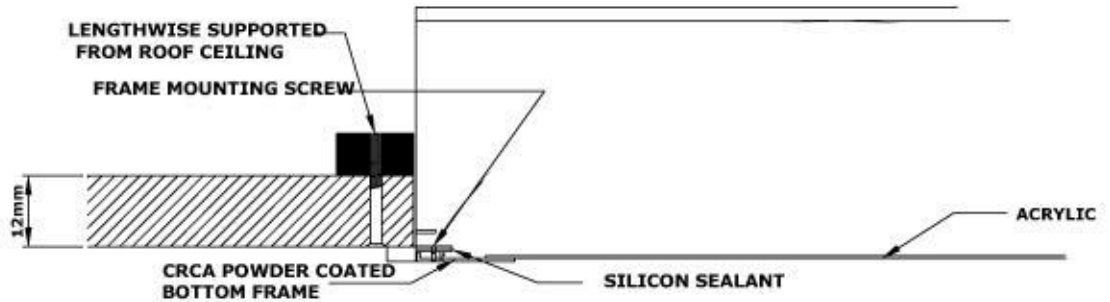

**CEILING CUTOUT 1200 mm X 400 mm**

					CLIENT	M/s.
					TITLE	
					DRG NO	20140827
					SHT	1 OF 1
					REV	00
NCK	JVN			00	<b>ELECTRA</b>	
MADE	CHKD	APPD	ALTERATION	REV		

## 36W - 60W LED TOP OPENING

### Description -

Family of Industrial Lighting Luminaries.  
Suitable to use in Cleanroom Areas.

### OCRTO 1901



### Features -

- Aesthetically designed housing made from CRCA
- Electro Statically Powder Coated, for excellent corrosion resistance,
- Removable led driver for easy maintainence,
- Bottom Frame, with Powder Coated Finish or SS 304 Grade,
- Two way connectors for Loop in - Loop out.
- Suitable for Class 100 to 1000 clean room applications
- As per IS 10322 / part1 / sec :1987

**Required Cut Out Size - 600x600mm**

### Optics -

Milky Acrylic Diffuser sealed with non hygroscopic - VHB gasket  
to ensure moisture proof and dustproof

### Installation -

Suitable for Slab Mounting, Walkable Modular Panels.

### Applications -

Biochem Industries, Pharmacuetical Industries, Chemical Industries,  
Sterilization rooms, Operation Theaters, Food & Beverage Industries,  
Hotels & Kitchen

**CLEAN ROOM FIXTURE  
36W - 60W LED TOP FITTING  
DIMENSION VIEW**

**BOTTOM VIEW**

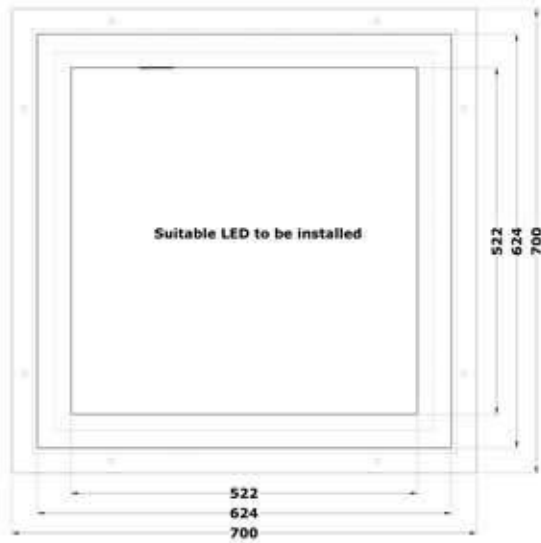

**TOP VIEW**

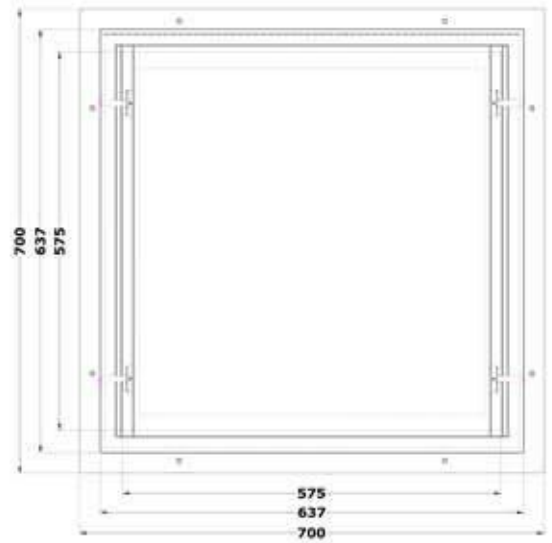

**MOUNTED & DIMENSION VIEW**



**CLOSE VIEW OF INSTALLATION**

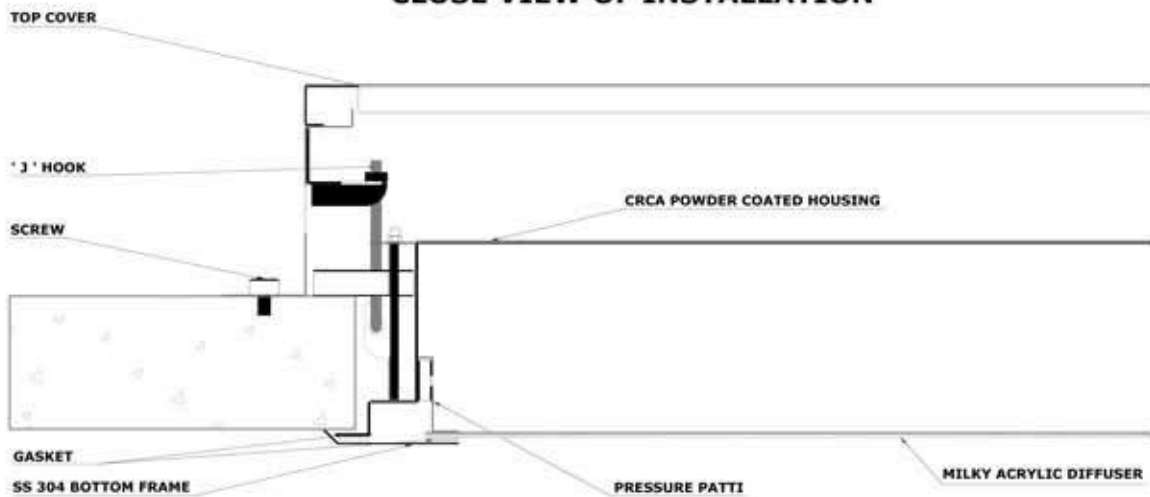

**Required Ceiling Cutout Dimension 600 x 600mm.**

					CLIENT :	
					TITLE :	
					DRG. NO.	SHT. 1 OF 1 REV
MADE	CHKD	APPD	ALTERATION	REV	<b>ELECTRA</b>	

## 18W - 25W LED TOP OPENING

### Description -

Family of Industrial Lighting Luminaries.  
Suitable to use in Cleanroom Areas.

**OCRTO 1902**



### Features -

- Aesthetically designed housing made from CRCA
- Electro Statically Powder Coated, for excellent corrosion resistance,
- Removable led driver for easy maintainence,
- Bottom Frame, with Powder Coated Finish or SS 304 Grade,
- Two way connectors for Loop in - Loop out.
- Suitable for Class 100 to 1000 clean room applications
- As per IS 10322 / part1 / sec :1987

**Required Cut Out Size - 300x300mm**

### Optics -

Milky Acrylic Diffuser sealed with non hygroscopic - VHB gasket  
to ensure moisture proof and dustproof

### Installation -

Suitable for Slab Mounting, Walkable Modular Panels.

### Applications -

Biochem Industries, Pharmacuetical Industries, Chemical Industries,  
Sterilization rooms, Operation Theaters, Food & Beverage Industries,  
Hotels & Kitchen

**CLEAN ROOM FIXTURE  
18-25W LED PCB RECESSED TOP OPENING**

**BOTTOM VIEW**

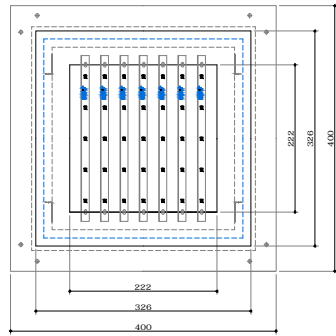

**TOP VIEW**

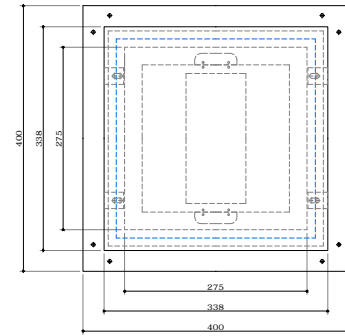

**LENGTHWISE SIDE VIEW**

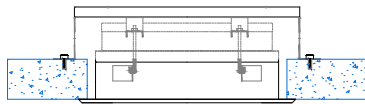

**WIDTHWISE SIDE VIEW**

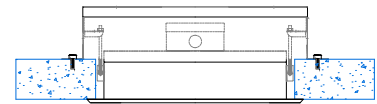

**MOUNTED & DIMENSION VIEW**

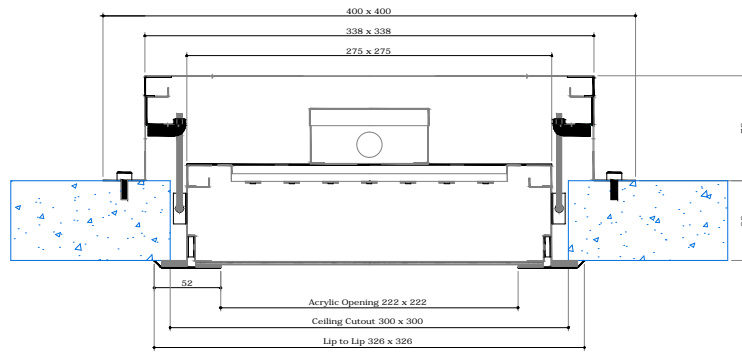

**CLOSE VIEW OF INSTALLATION**

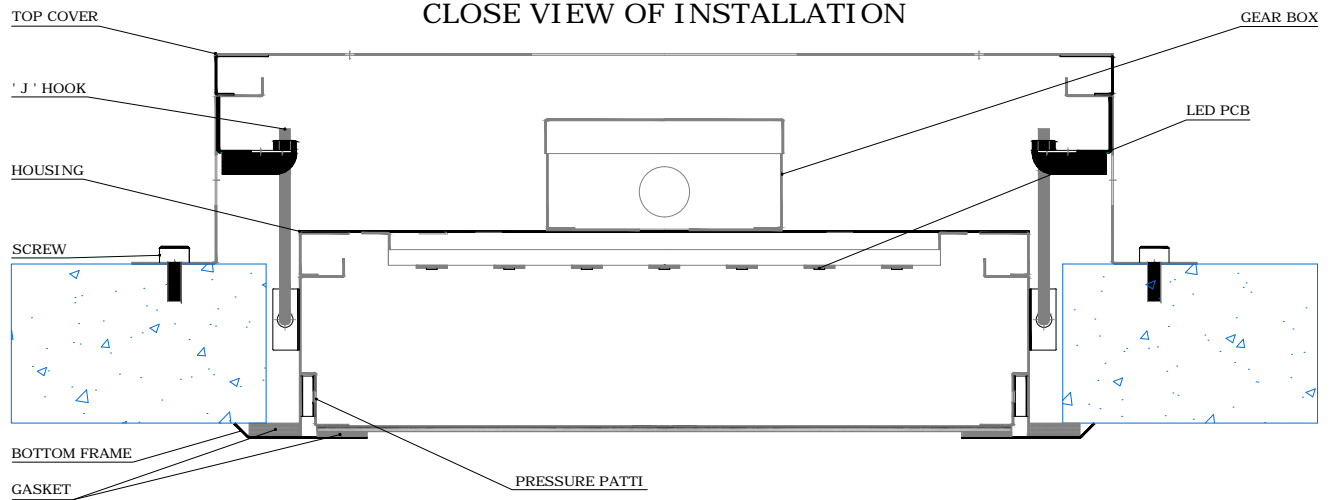

**Required Ceiling Cutout Dimension 300 x 300mm.**

					CLIENT :
					TITLE : <b>18-25W LED PCB recessed top opening</b>
					DRG. NO. <span style="float: right;">SHT. 1 OF 1 REV</span>
MADE	CHKD	APPD	ALTERATION	REV	<b>ELECTRA</b>



## 24W - 45W LED TOP OPENING

### Description -

Family of Industrial Lighting Luminaries.  
Suitable to use in Cleanroom Areas.

**OCRTO 1903**



### Features -

- Aesthetically designed housing made from CRCA
- Electro Statically Powder Coated, for excellent corrosion resistance,
- Removable led driver for easy maintainence,
- Bottom Frame, with Powder Coated Finish or SS 304 Grade,
- Two way connectors for Loop in - Loop out.
- Suitable for Class 100 to 1000 clean room applications
- As per IS 10322 / part1 / sec :1987

**Required Cut Out Size - 300x600mm**

### Optics -

Milky Acrylic Diffuser sealed with non hygroscopic - VHB gasket  
to ensure moisture proof and dustproof

### Installation -

Suitable for Slab Mounting, Walkable Modular Panels.

### Applications -

Biochem Industries, Pharmacuetical Industries, Chemical Industries,  
Sterilization rooms, Operation Theaters, Food & Beverage Industries,  
Hotels & Kitchen

**CLEAN ROOM FIXTURE  
24W - 45W LED TOP OPENING  
DIMENSION VIEW**

**BOTTOM VIEW**

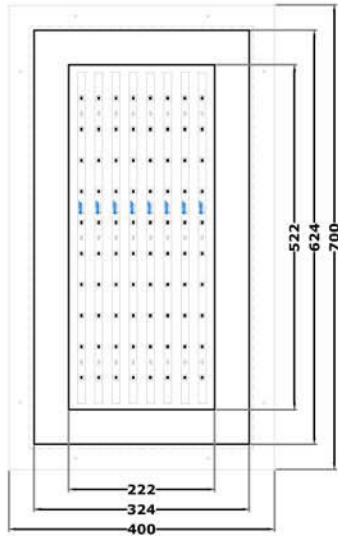

**TOP VIEW**

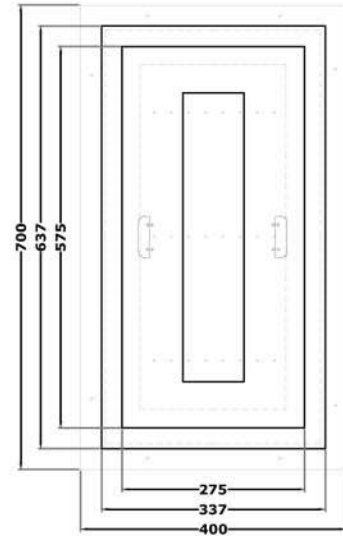

**LENGTHWISE SIDE VIEW**



**WIDTHWISE SIDE VIEW**

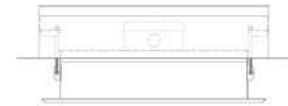

**MOUNTED & DIMENSION VIEW**

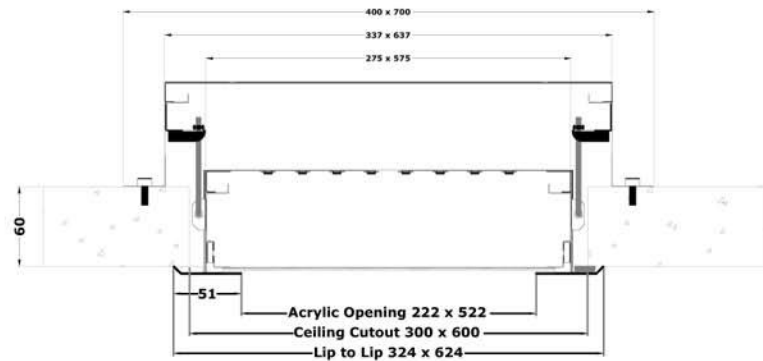

**CLOSE VIEW OF INSTALLATION**

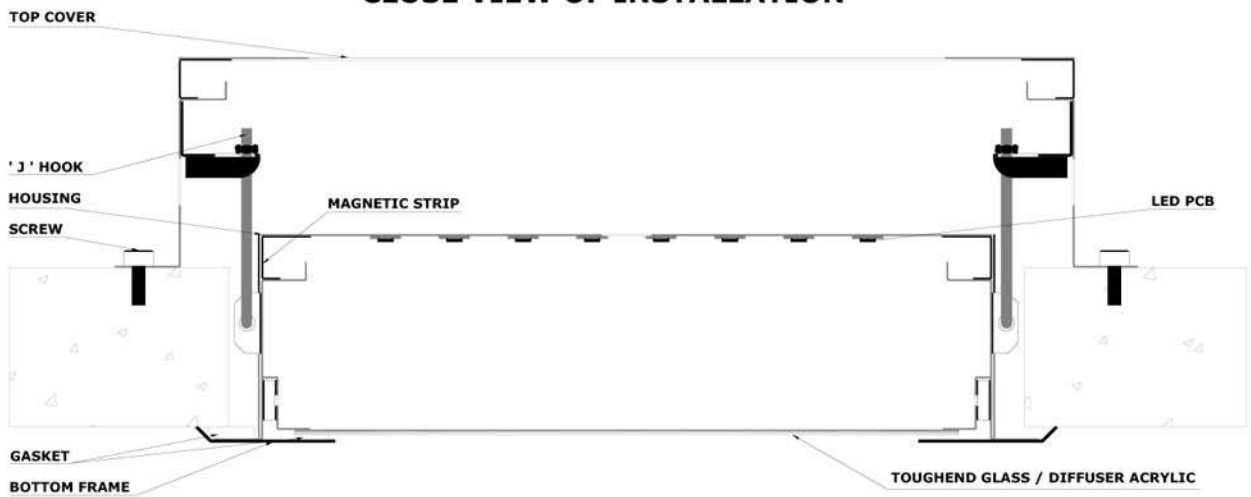

**Required Ceiling Cutout Dimension 300 x 600mm.**

					CLIENT :		
					TITLE :		
					DRG. NO.	SHT. 1 OF 1	REV
MADE	CHKD	APPD	ALTERATION	REV	<b>ELECTRA</b>		

## 36W - 60W LED BOTTOM OPENING

### Description -

Family of Industrial Lighting Luminaries.  
Suitable to use in Cleanroom Areas.

### OCRBO 1801

### Features -

Aesthetically designed housing made from CRCA  
Electro Statically Powder Coated, for excellent corrosion resistance,  
Removable led driver for easy maintainence,  
Bottom Frame, with Powder Coated Finish or SS 304 Grade,  
All screws for bottom frame are from SS 304  
Two way connectors for Loop in - Loop out.  
Suitable for Class 10,000 to 1 00 000 clean room applications  
As per IS 10322 / part1 / sec :1987

**Dimensions available - 600x600mm / 500x500mm**

### Optics -

Milky Acrylic Diffuser sealed with non hygroscopic - VHB gasket  
to ensure moisture proof and dustproof

### Installation -

Suitable for Slab Mounting, Walkable Modular Panels.

### Applications -

Biochem Industries, Pharmacuetical Industries, Chemical Industries,  
Sterilization rooms, Operation Theaters, Food & Beverage Industries,  
Hotels & Kitchen



# CLEAN ROOM FIXTURE

## 36W - 60W LED SURFACE MOUNTED FITTING

**BOTTOM VIEW**

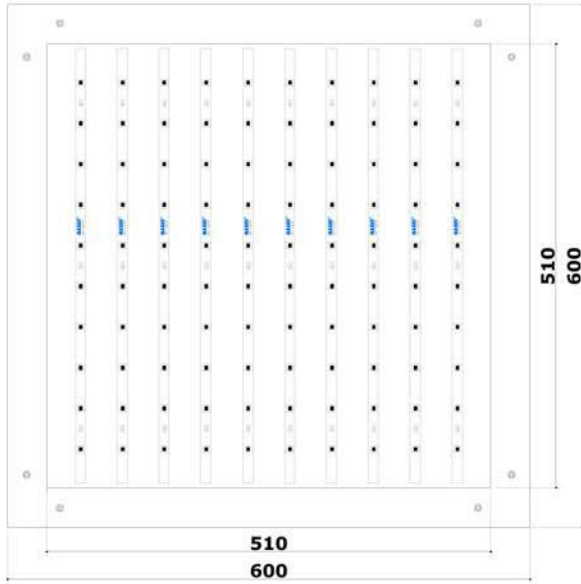

**TOP VIEW**

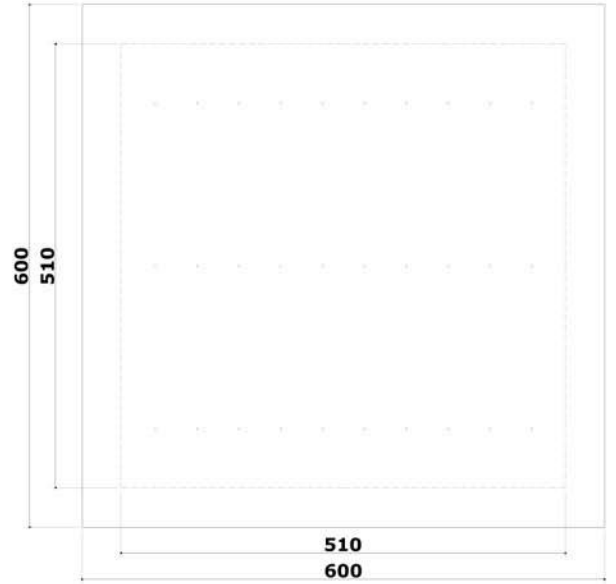

### MOUNTED & DIMENSION VIEW

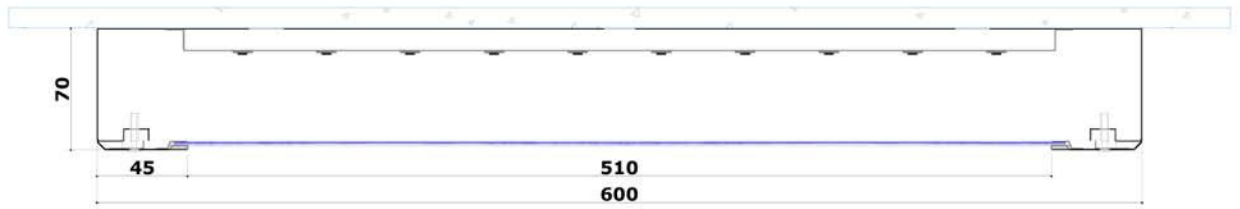

### CLOSE VIEW OF INSTALLATION

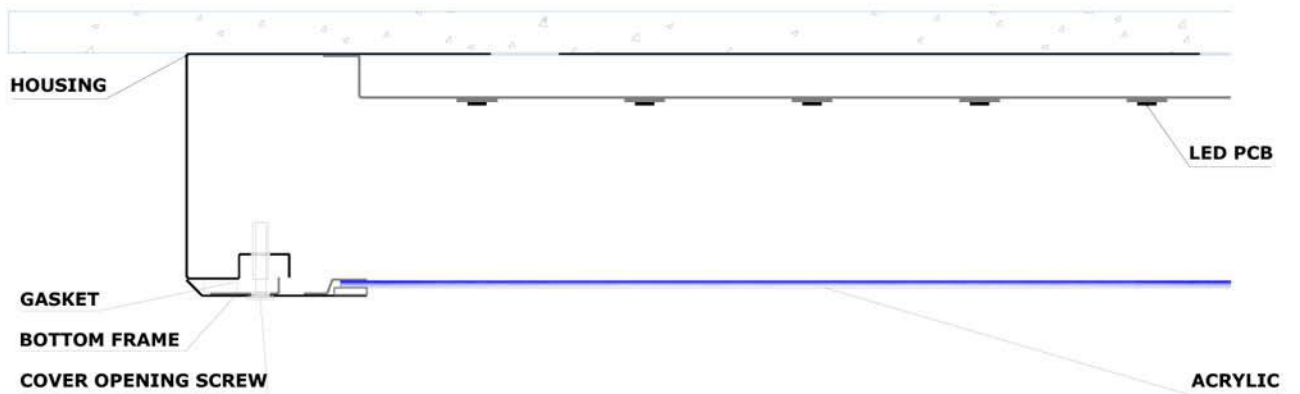

				CLIENT :	
				TITLE :	
				DRG. NO.	SHT. 1 OF 1    REV
MADE	CHKD	APPD	ALTERATION	REV	<b>ELECTRA</b>

## 18W - 25W LED BOTTOM OPENING

### Description -

Family of Industrial Lighting Luminaries.  
Suitable to use in Cleanroom Areas.

### OCRBO 1802



### Features -

- Aesthetically designed housing made from CRCA
- Electro Statically Powder Coated, for excellent corrosion resistance,
- Removable led driver for easy maintainence,
- Bottom Frame, with Powder Coated Finish or SS 304 Grade,
- All screws for bottom frame are from SS 304
- Two way connectors for Loop in - Loop out.
- Suitable for Class 10,000 to 1 00 000 clean room applications
- As per IS 10322 / part1 / sec :1987

**Dimensions available - 300x300mm**

### Optics -

Milky Acrylic Diffuser sealed with non hygroscopic - VHB gasket  
to ensure moisture proof and dustproof

### Applications -

Biochem Industries, Pharmacuetical Industries, Chemical Industries,  
Sterilization rooms, Operation Theaters, Food & Beverage Industries,  
Hotels & Kitchen

# CLEAN ROOM FIXTURE

## 18W - 25W LED SURFACE MOUNTED FITTING

**BOTTOM VIEW**

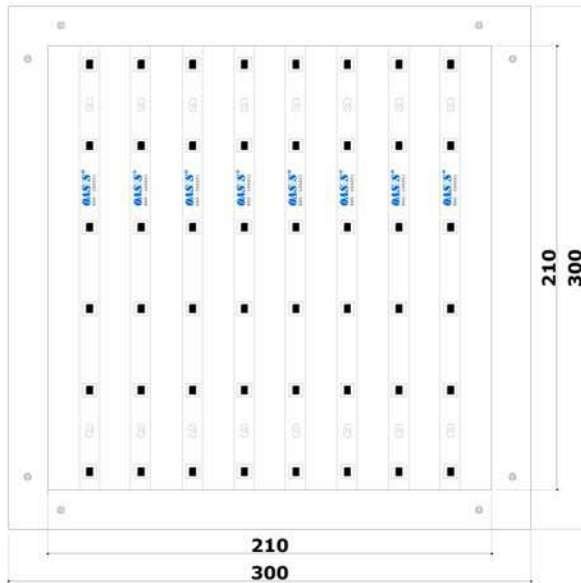

**TOP VIEW**

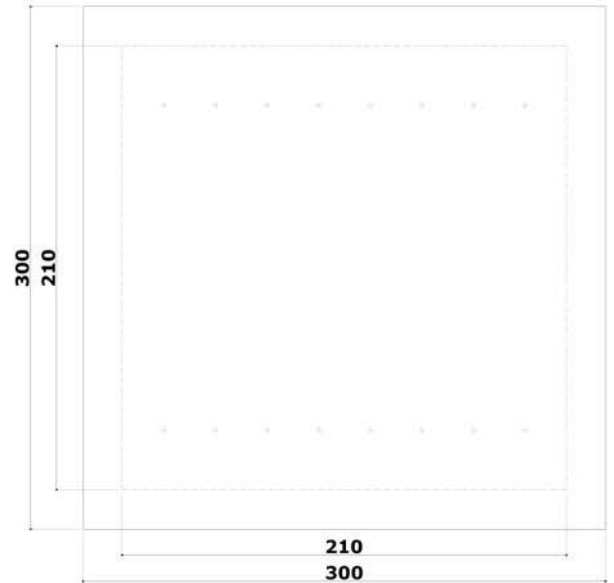

### MOUNTED & DIMENSION VIEW

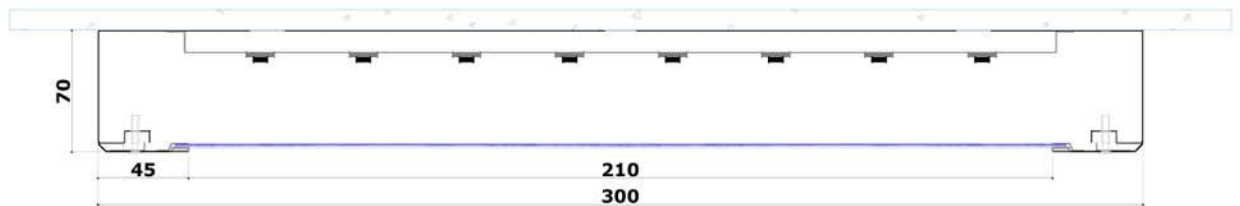

### CLOSE VIEW OF INSTALLATION

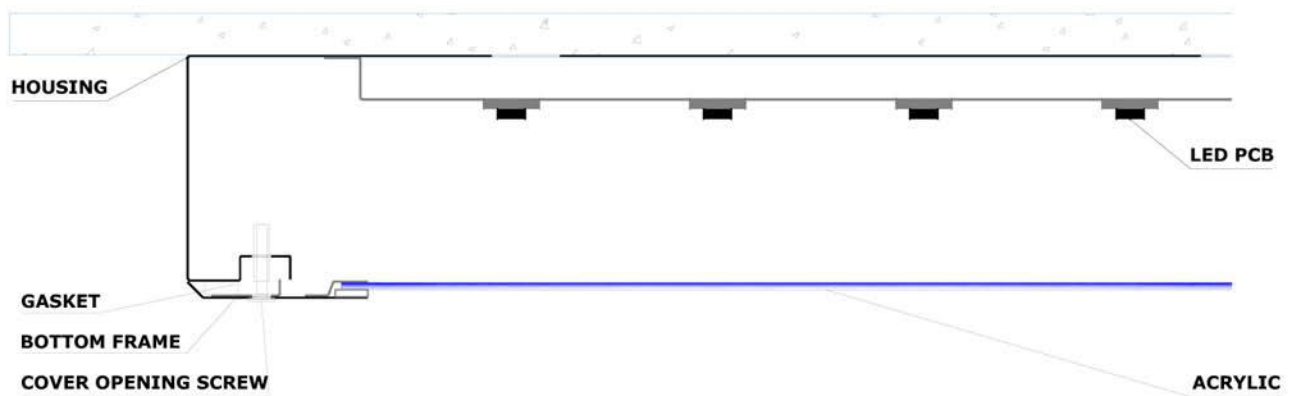

							CLIENT :
							TITLE :
							DRG. NO.
						SHT. 1 OF 1	REV
MADE	CHKD	APPD	ALTERATION	REV	<b>ELECTRA</b>		

We can do it all for you.

- Clean Rooms & Laboratories
- Lights & Lighting Systems
- Green Building
- Development & Design
- General Planning

**ELECTRA**

# 5-2-283 / A, Plot No. 9 & 10, 1st Floor,  
A.N.Complex, Hyderbasti, Secunderabad -3  
A.P. India.

E-mail : [info@electrasols.com](mailto:info@electrasols.com)  
[info@electroautomation.com](mailto:info@electroautomation.com)

Telephone : 040-66385405 / 6 / 7

Fax : 040-27540037